

Montaža pohištva

Opomba: Pred začetkom sestavljanja pohištva preberite vsa navodila za sestavljanje pohištva, vključno s pravili za vzdrževanje in uporabo. Upoštevajte zaporedje posameznih stopenj montaže v skladu z odstavki ⚠ iz Splošnih pravil za montažo pohištva.

TA NAVODILA HRANITE VES ČAS UPORABE POHIŠTVA.

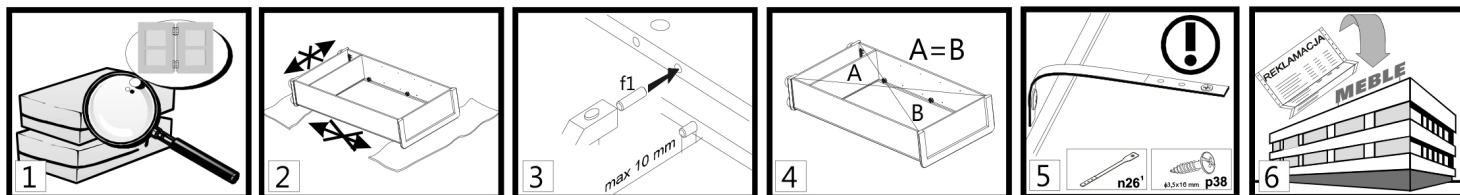

1. OPOMBA! Ne nadaljujte z montažo, če je katera koli komponenta okvarjena ali poškodovana.
2. Sestavne dele med sestavljanjem položite na mehko in čisto površino, npr. na brisačo ali odejo. Pohištva ne sestavljajte na krpah, preprogah itd.
3. V luknje s premerom 8 mm, ki se nahajajo na robovih sestavnih delov, vstavite zatiče f1. Odprtine za odmične vijake pustite proste. Vsak čep, ki štrli ven za več kot 10 mm, je treba izvleči, zamenjati in skrajšati, saj lahko med sestavljanjem poškoduje stransko steno.
4. Pred pritrditvijo zadnje stene se prepričajte, da so diagonale enako dolge.
5. OPOMBA: Varnostni trak. Namestite ga v skladu z navodili. Nepravilno pritrjeno pohištvo se lahko med uporabo odtrga in pade.
6. Spoštovani kupec, v primeru reklamacij navedite šifro, ki je navedena na prvi strani navodil za montažo. Prijavite vse pripombe in pritožbe tam, kjer ste pohištvo kupili. Če je mogoče, predložite etiketo okvarjenega izdelka z navedbo datuma pakiranja in tistega, ki ga je pakiral.



Pojasnila / morebitne opombe, uporabljene v navodilih za sestavljanje:

Simbol sestavnega dela	Koda	Dimenzije [mm]	Količina [kosov]	Pakiranje	
§1	A	B	C	D	E

Prva faza montaže vključuje namestitve sestavnih delov z ustrežno dodatno opremo, kot je določeno na spodnjih risbah.

§2 Simbol Ⓢ označuje mesta, kjer je potrebna posebna previdnost med sestavljanjem.

Nastavitveni vijak uravnava odpiranje vratnih loput omarice (zategnite vijak da se vrata zaklopa ohišja prosto spuščajo). POZOR!!! Pomanjkanje oz neustrezna nastavitvev predstavlja nevarnost, da vrata lopute prosto padajo.

§3 POZOR!!! Ko je enota v celoti sestavljena, jo pritrdite na steno. Nepravilno pritrjeno pohištvo se lahko med montažo ali uporabo odtrga in pade. Enoto lahko na steno pritrdi le usposobljena oseba. Pred tem preverite, ali je stena primerna za pritrditev pohištva nanjo. Izberite ustrezen pritrdilni vijak ter preverite trdnost in kakovost pritrditve.

§4 POZOR!!! Postavite zgornjo enoto na osnovno enoto, nato ju združite s priključno ploščo n52 in vijaki p25. Če tega navodila ne upoštevate, se lahko enota med uporabo odtrga in pade.

§5 Enoto sestavite v skladu s spodnjimi risbami z uporabo določenih priključkov in/ali spojev.

§6 POZOR! Postopek je treba izvesti zelo previdno, da ne pride do poškodb delov izdelka.

§7 V luknje prikazanega sestavnega dela nanesite lepilo y1, ga pritrdite in počakajte, da se lepilo posuši.

§8 Lepljeno območje temeljito očistite.

§9 Nastavitvev

§10 POZOR!!! S steklenimi komponentami ravajte še posebej previdno, da se ne bi porezali ali poškodovali ali zlomili komponent.

§11

§12 Izvrtajte luknje v skladu z risbami. Med tem postopkom bodite še posebej previdni, da se ne porežete ali poškodujete komponente!

§13 Vijake e8 zategnite tako, da ne štrlijo čez rob

§14 Možnost

§15 Vložek postavite na okvir z glavo navzdol na mesto, ki je namenjeno za ta sestavni del, pri tem pa uporabite razgrnjeno zgornjo enoto.

§16 Priporočena velikost vzmetnice

§17 Sosednje enote povežite s priključnimi vijaki VHS.

OPOMBA!!!

§18 Uporabite varnostni trak, saj je to nujno za zagotavljanje varnosti oseb, ki uporabljajo vaše pohištvo.

§19 Vrata so lahko nameščena na levi ali desni strani enote.

§20 OPOMBA!!! Posteljna enota in loputa se pri zapiranju nagibata k zatikanju. Obstaja nevarnost poškodb.

§21 Na vidnih mestih namestite maskirni trak/enoto.

§22 POZOR!!! Pohištvo se lahko sprosti in pade, če se ne uporablja previdno.

§23 POZOR!!! Fronte z visokim sijajem so prekrite z zaščitno folijo, ki jo je treba odstraniti, ko je sestavni del obešen. Površine teh front ni mogoče čistiti, dokler ne pretečejo vsaj 4 tedni po odstranitvi zaščitne folije.



Elementi dodatne opreme, namenjeni za samopostrežno nakupovanje v specializiranih trgovinah.

Uporaba in vzdrževanje pohištva

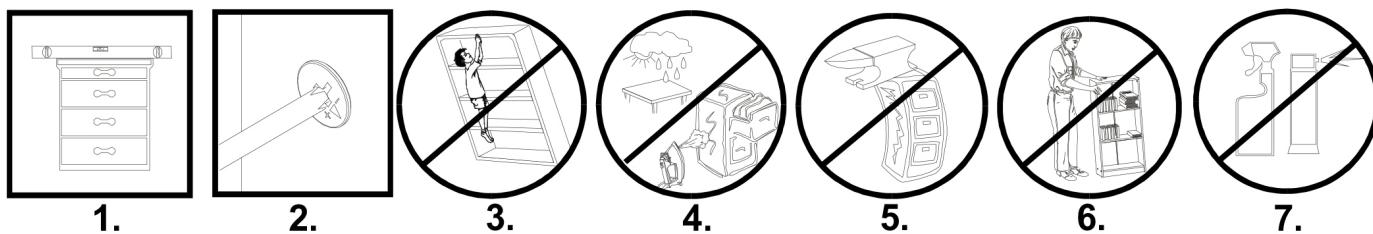

1. Pohištveni elementi morajo biti postavljeni na ravno površino in poravnani.
2. Med uporabo pohištvene enote preverjajte stanje odmičnih zatičev. Po potrebi jih zategnite.
3. POZOR!!! Ne plezajte na pohištvo
4. Pohištvo je treba postaviti v suhe prostore z delujočim prezračevanjem in vsaj 1 m od aktivnih virov toplote. Prostori morajo biti zaščiteni pred škodljivimi vremenskimi vplivi (sončna svetloba, dež itd.).
5. POZOR!!! Nameščanje prevelikih obremenitev na pohištvo je nevarno za uporabnike in lahko povzroči trajne poškodbe.
6. Pohištvo je treba premikati tako, da ga dvignete brez obremenitve. Opomba: premikanje ali vlečenje pohištva lahko povzroči trajne poškodbe. Pri premikanju se držite za navpične elemente enote, tj. za stranice in noge. Ne prijemajte za vodoravne elemente, npr. strukturne police ali predale, saj se ti lahko poškodujejo.
7. Pohištvo čistite z vlažno krpo ali papirnato brisačo.

GRABIE-1D

B186-SZF1D



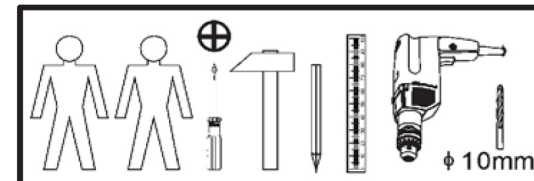
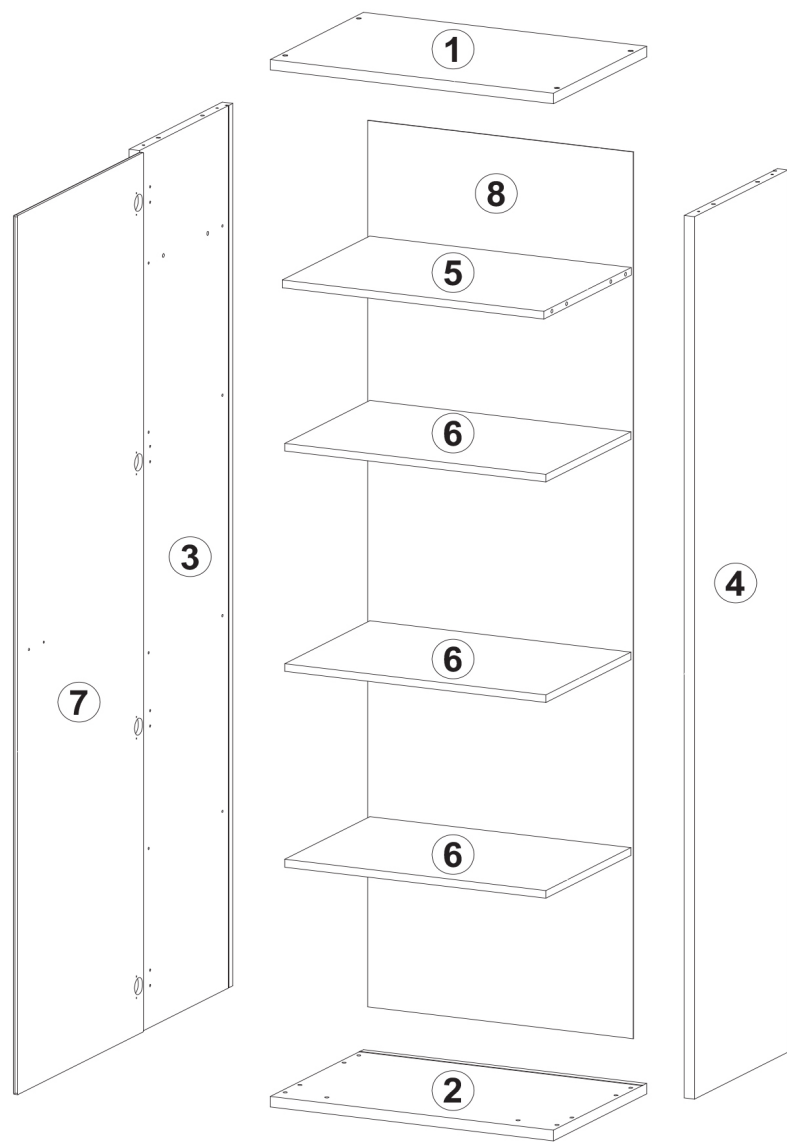
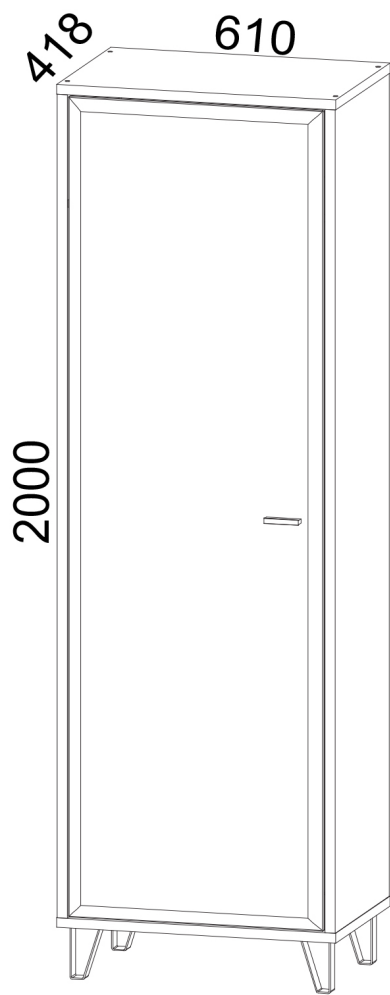
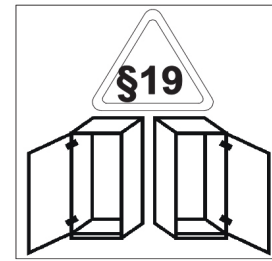

A	B	C			D	E
1	B186-204	610	405	22	1	1/3
2	B186-205	610	405	22	1	1/3
3	B186-103	1836	405	22	1	1/3
4	B186-104	1836	405	22	1	1/3
5	B186-303	564	379	16	1	1/3
6	B186-304	563	370	15	3	2/3
7	B186-003	1830	558	19	1	2/3
8	B186-902	1845	572	2,5	1	2/3
9	dodatki				1	3/3

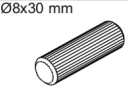

a203 x4	a63 x4	b90 x4	D5mm	d1 x12	d4 x1	f1 x12	m22/1 x1
r42 x4	r1 x4	s2 x4	p38 x23	p51 x12	e27 x8	l2 x20	z1 x1
n14/2 x1	f35 x1	p17 x1	s59 x13	cb6 x1	j8 x2	nb1 x4	

1



 r1	 x4 f1	 x12 f1	 r42	 x4
--	---	--	---	--

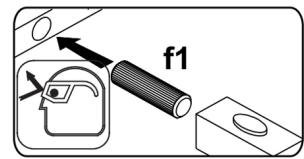
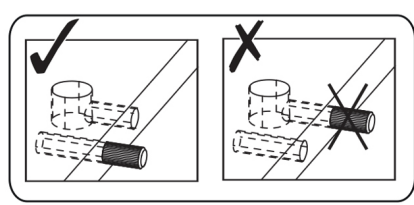
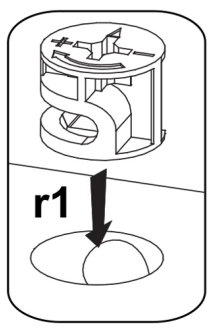
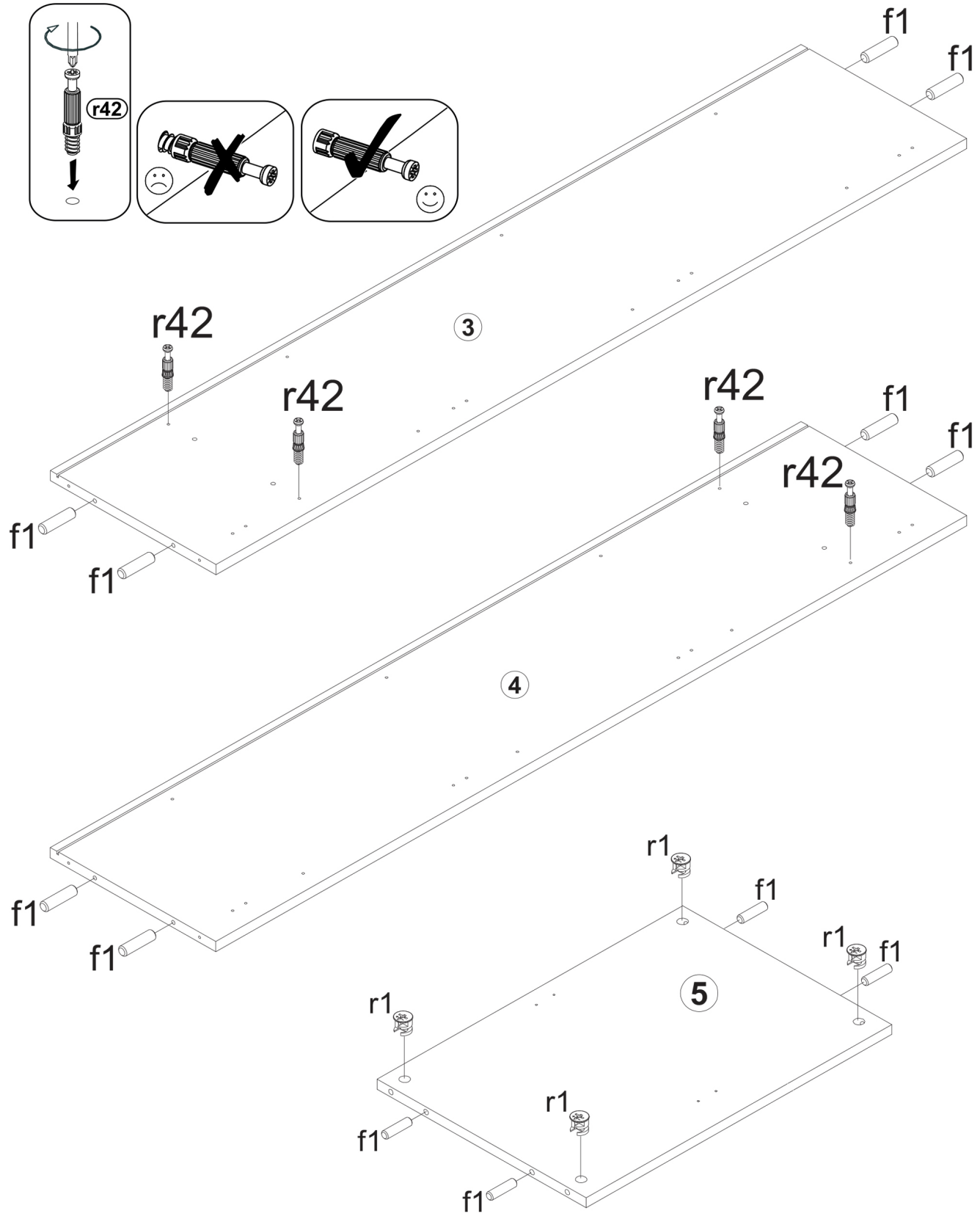
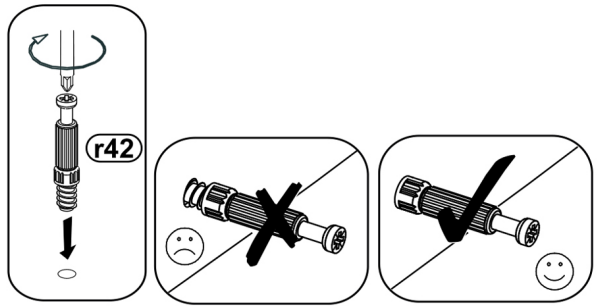

2

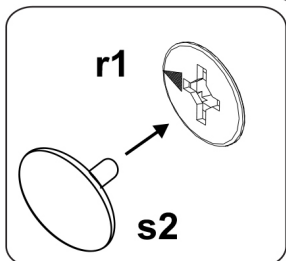
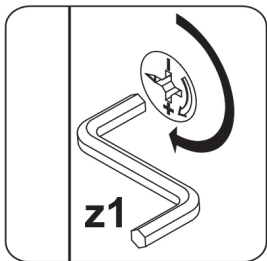
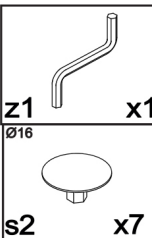
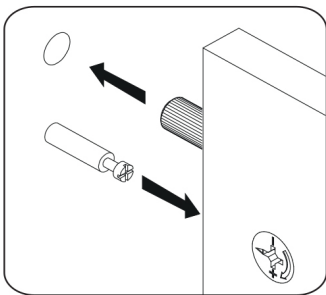
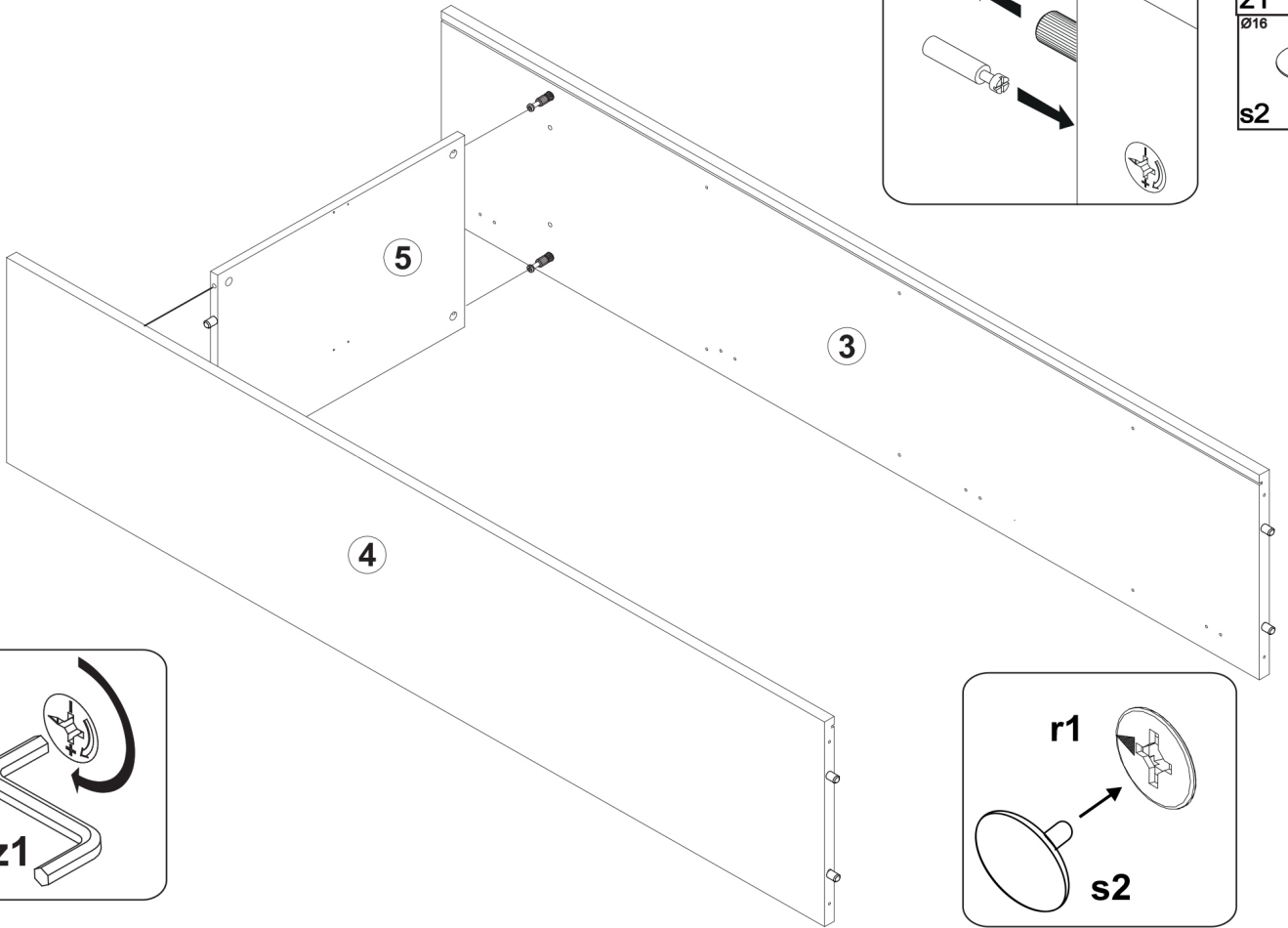

3

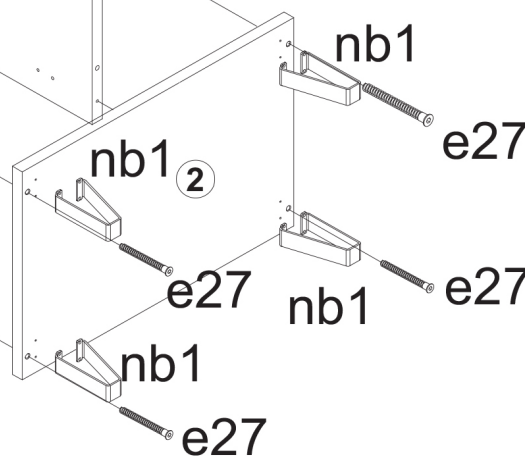
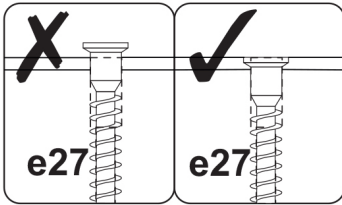
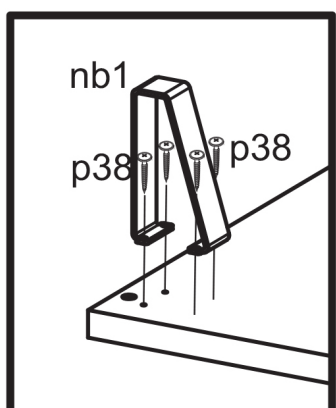
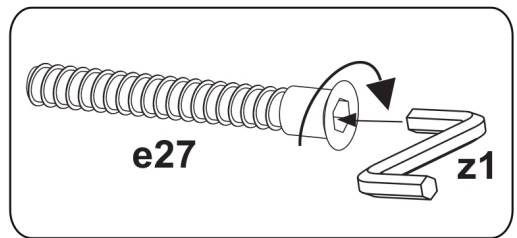
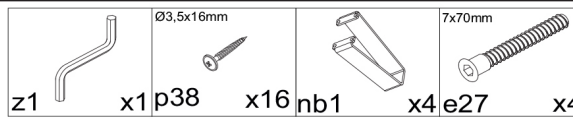
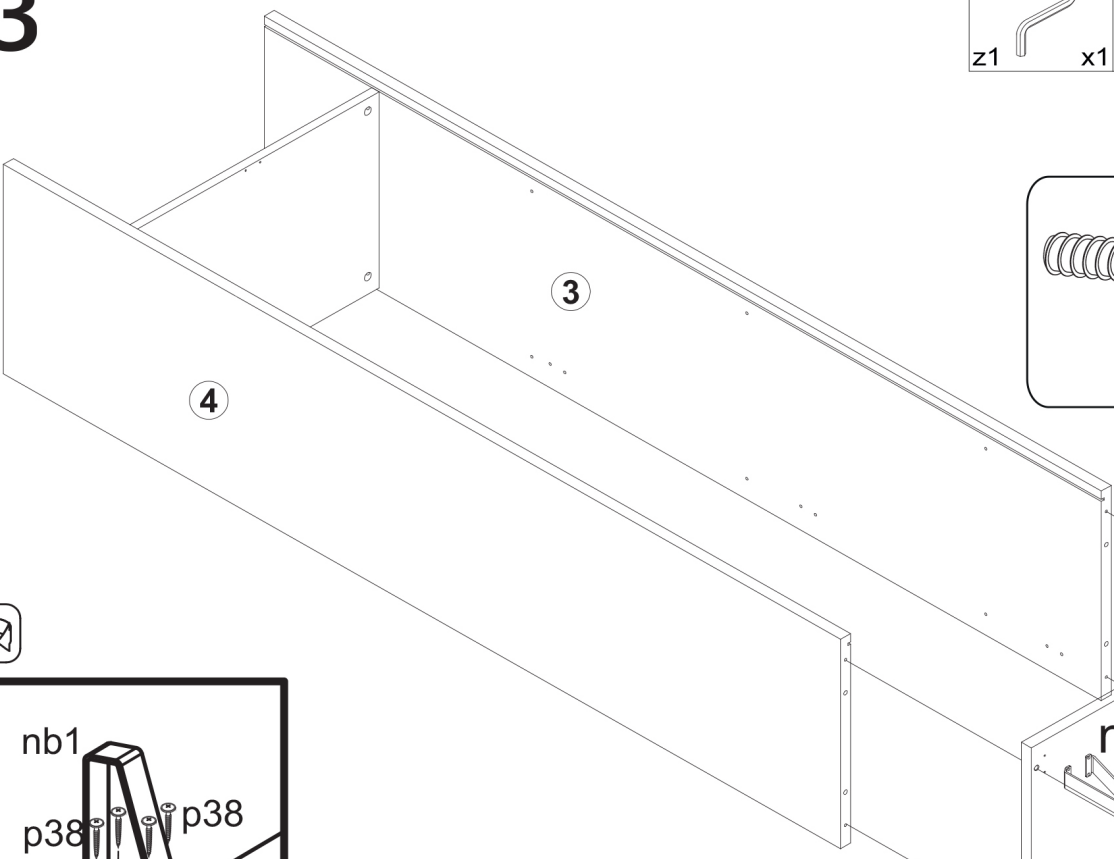

4

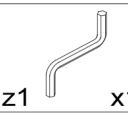
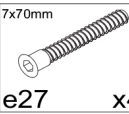
	
z1	x1 e27 x4

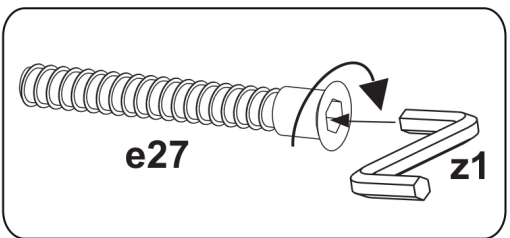
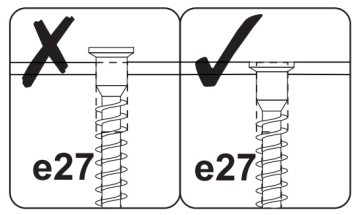
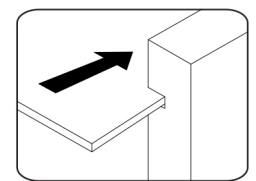
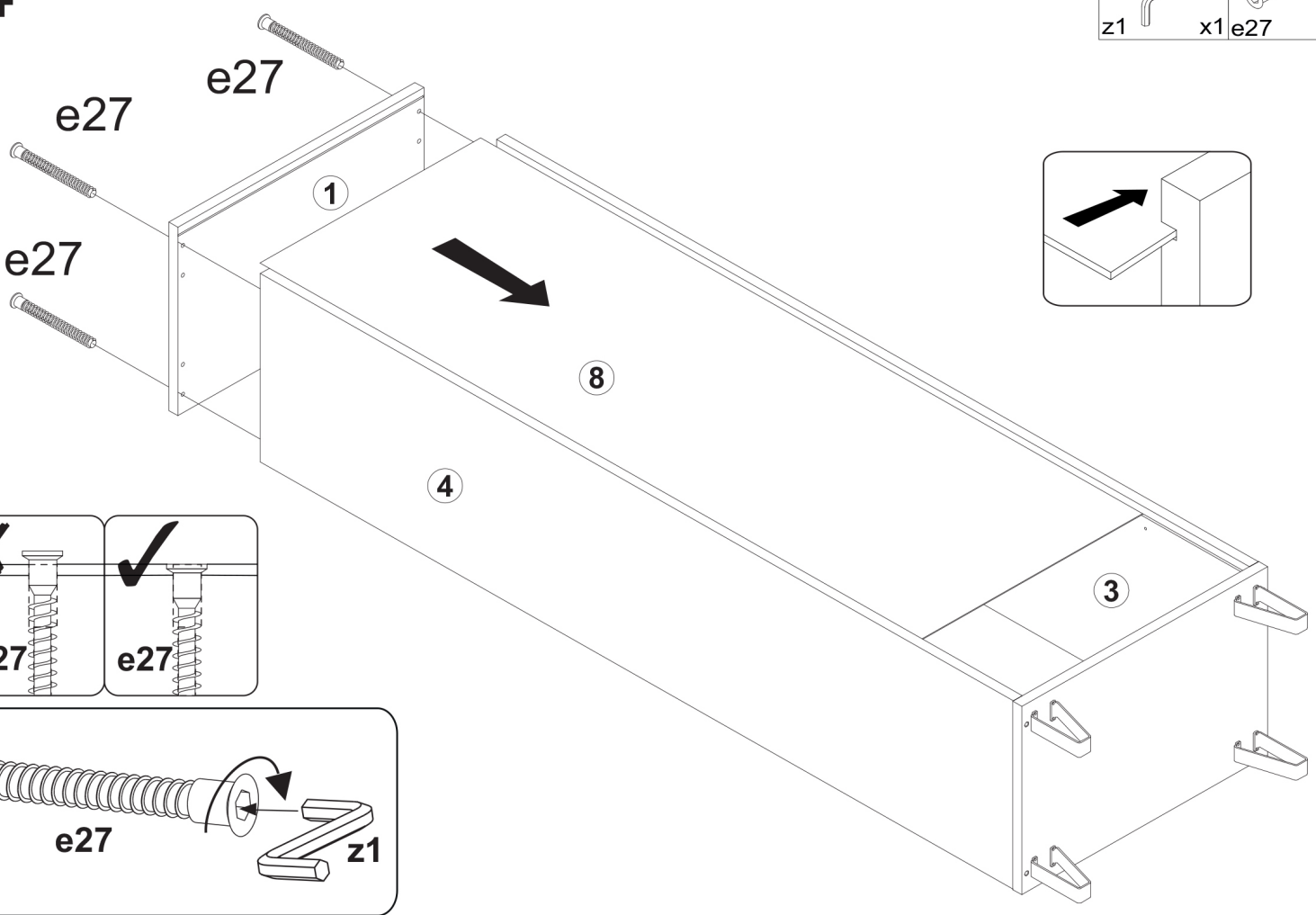



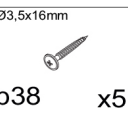
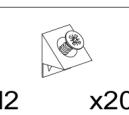

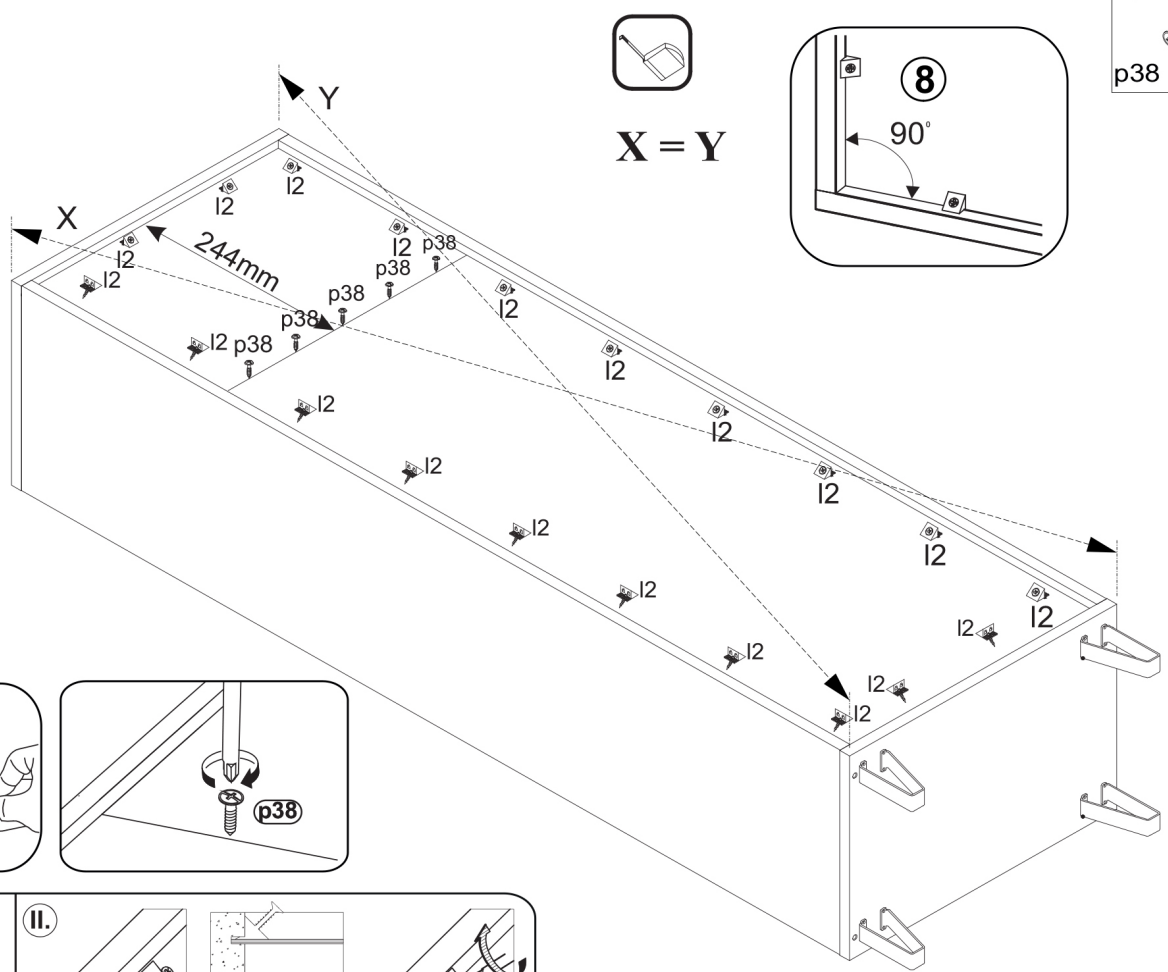
5

	
Ø3,5x16mm p38	x5 I2 x20

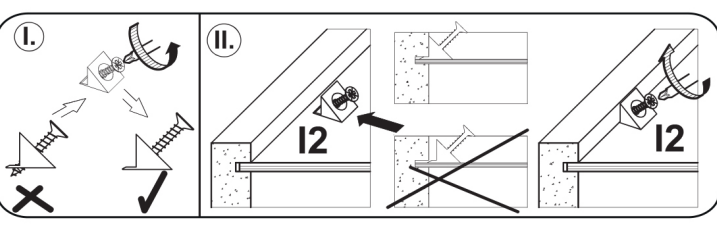
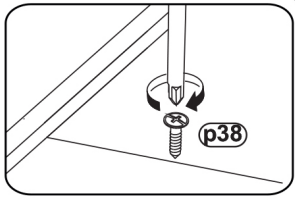
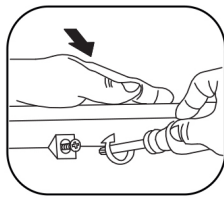
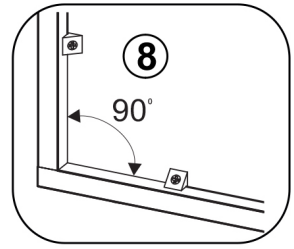



X = Y

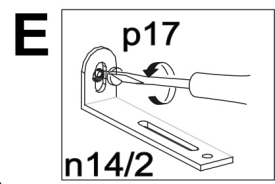
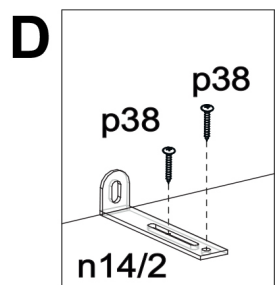
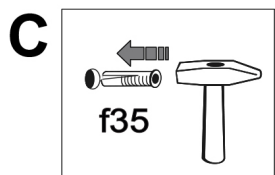
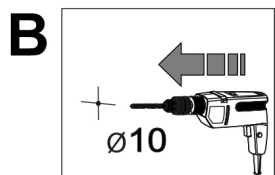
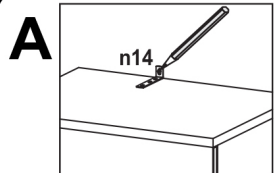
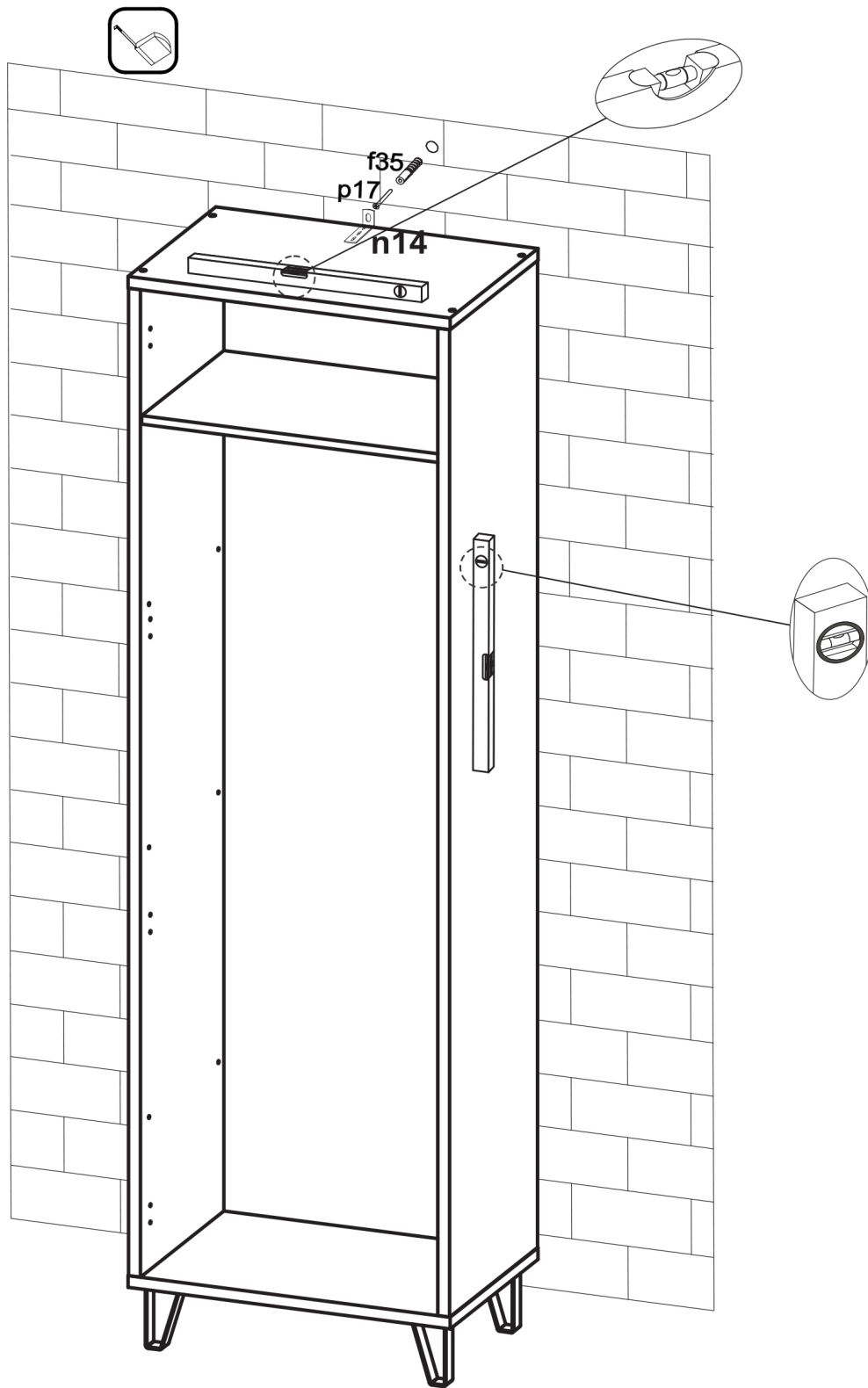
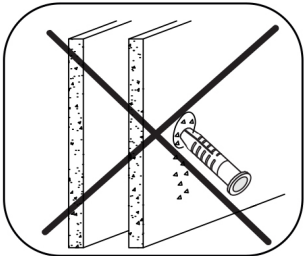
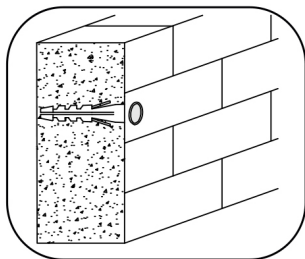

 Ø5x50mm	 10x50mm	 86x21x15/1,5mm	 Ø3,5x16mm	x1	x1	x1	x2
--	--	---	--	----	----	----	----

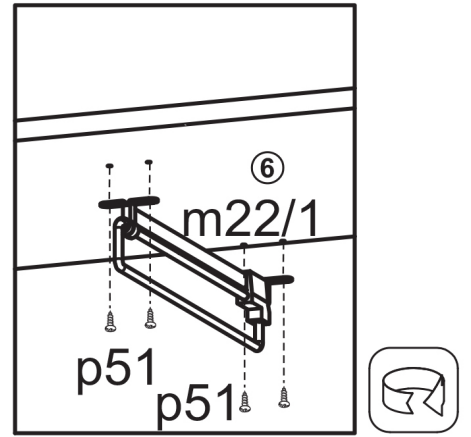
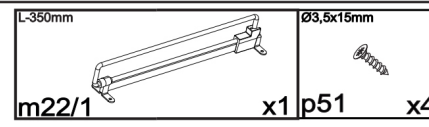
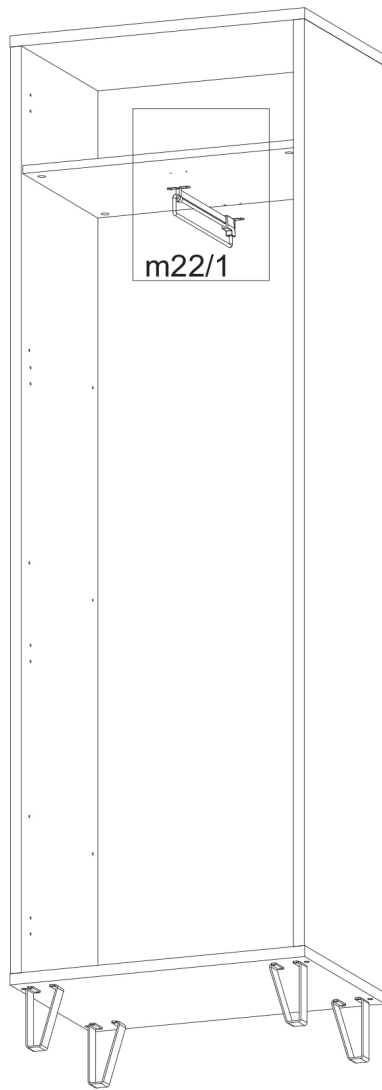
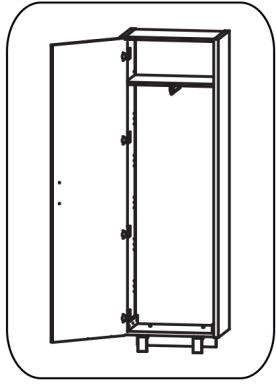

7



7

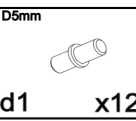
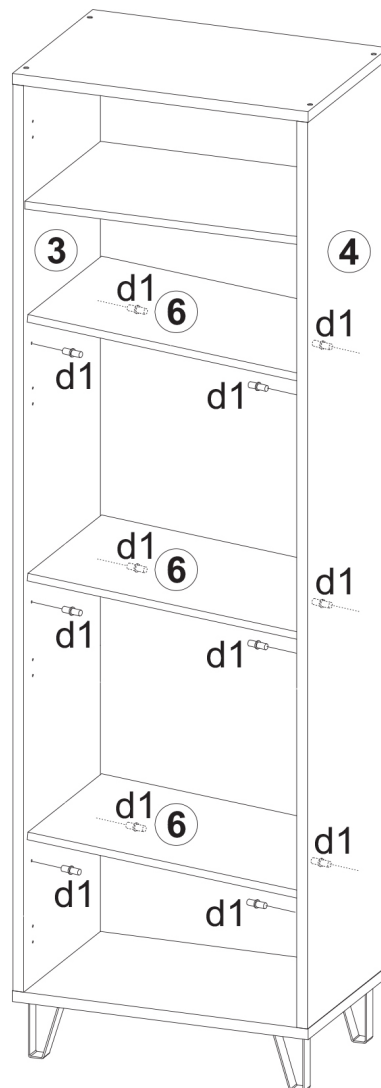
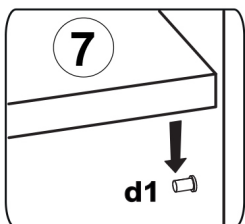
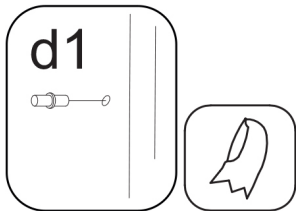
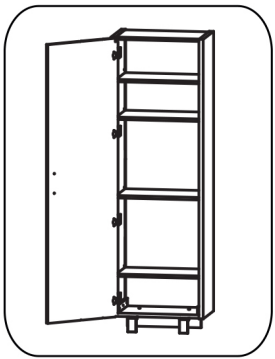

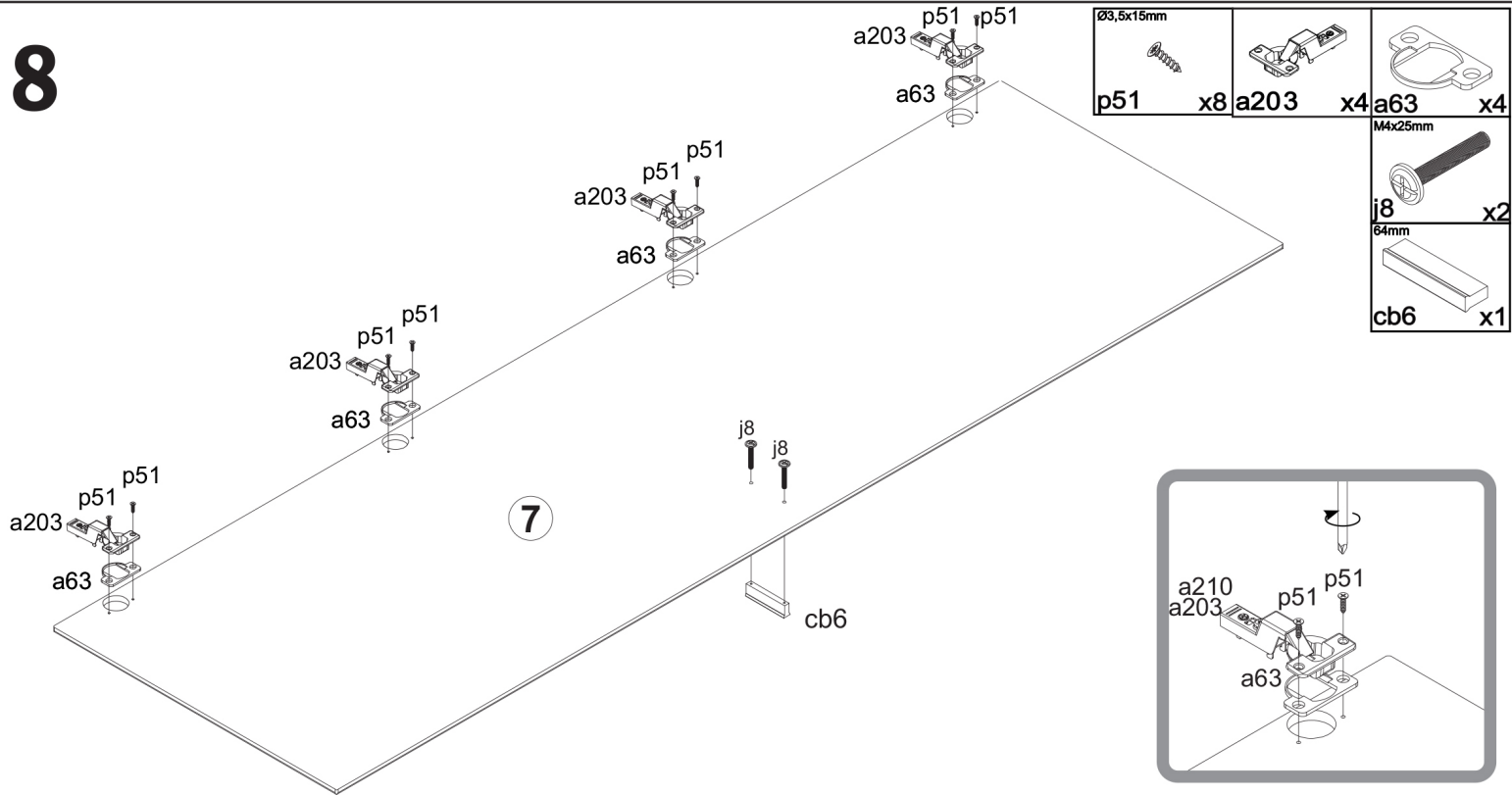

8

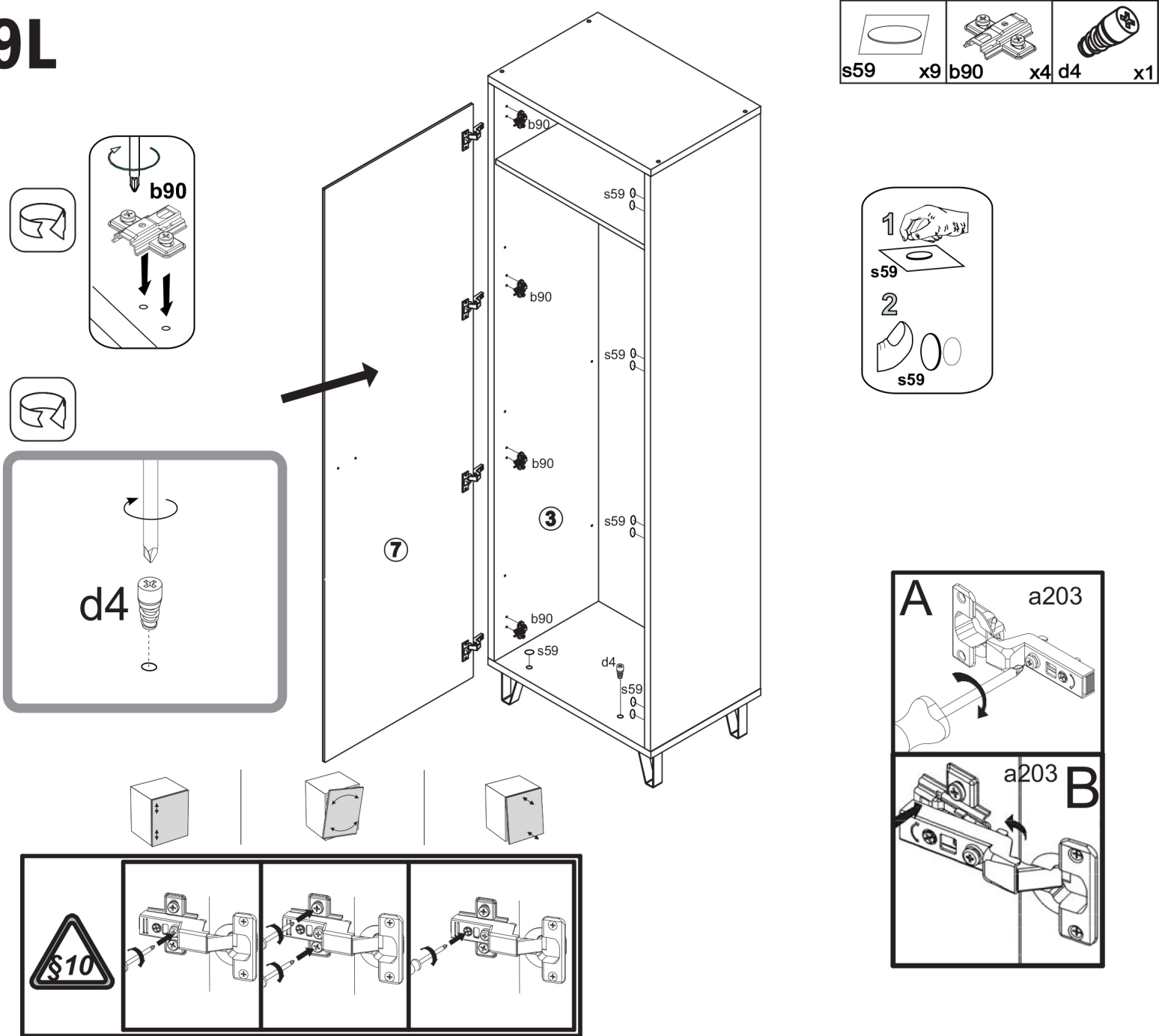

9L

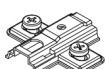

9R

					
s59	x9	b90	x4	d4	x1

